

InMoov Parts Catalog

Rev 1.1 10/2015

Revwarguy

With Thanks to Gael, Anar, and Damon

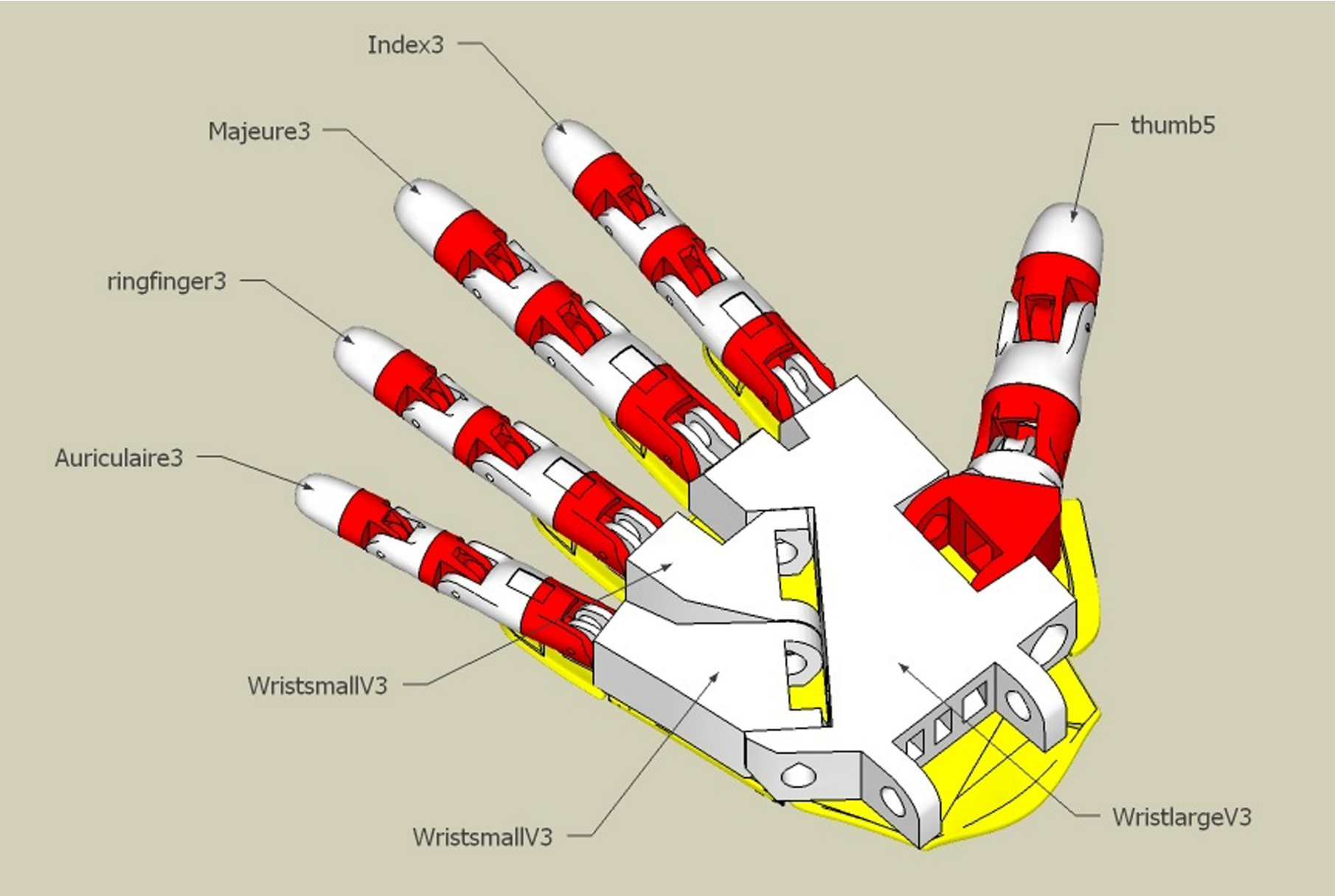

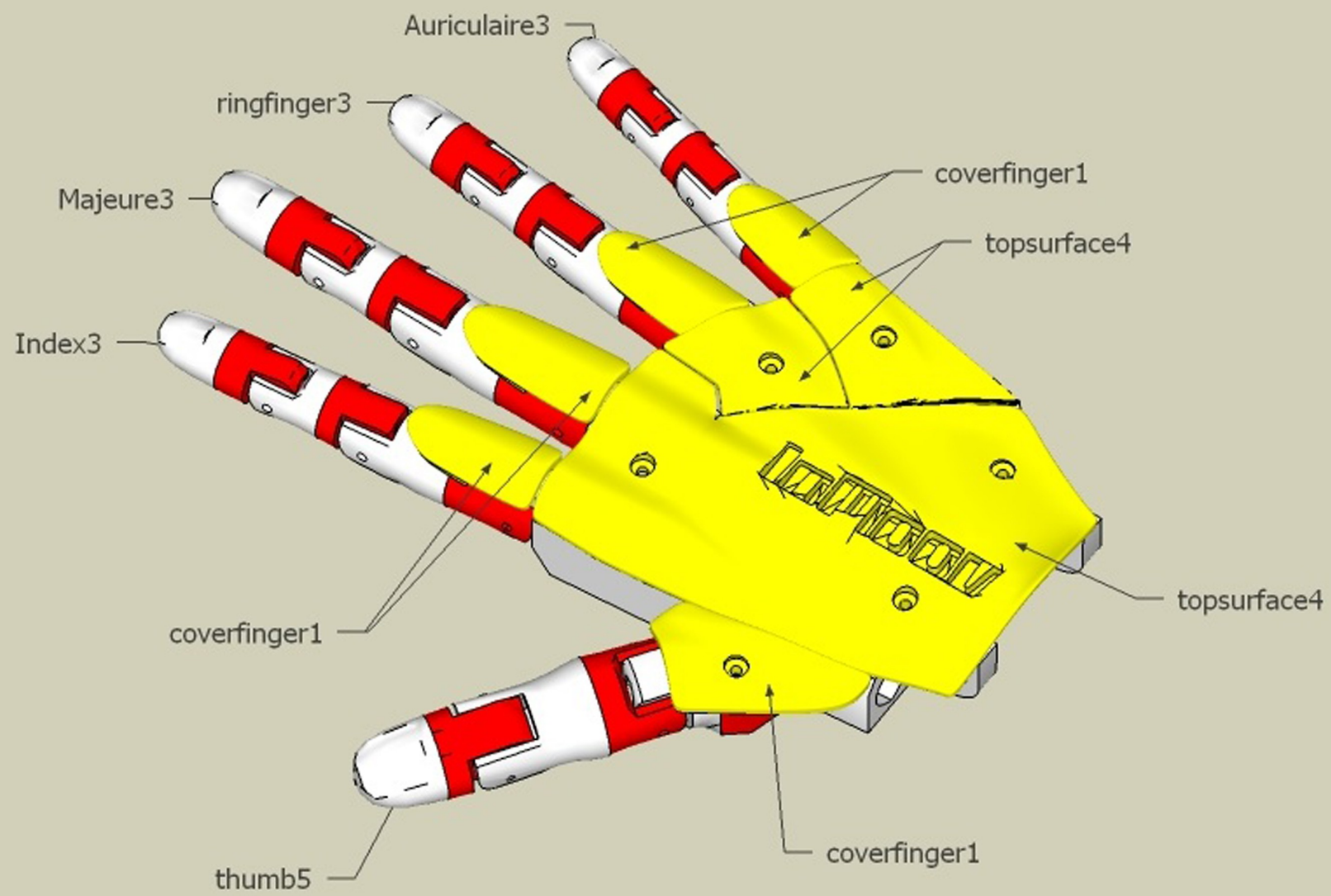

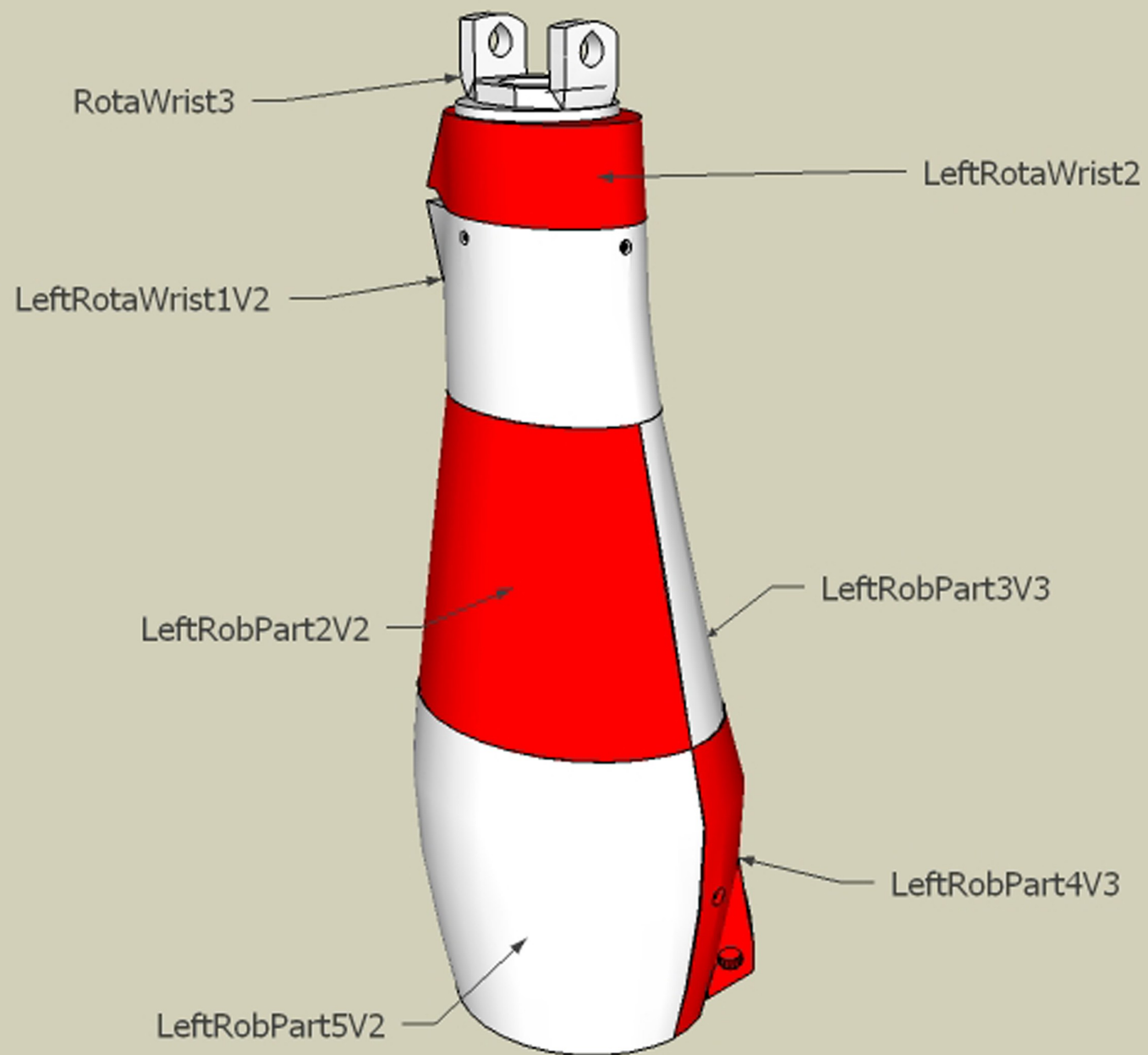

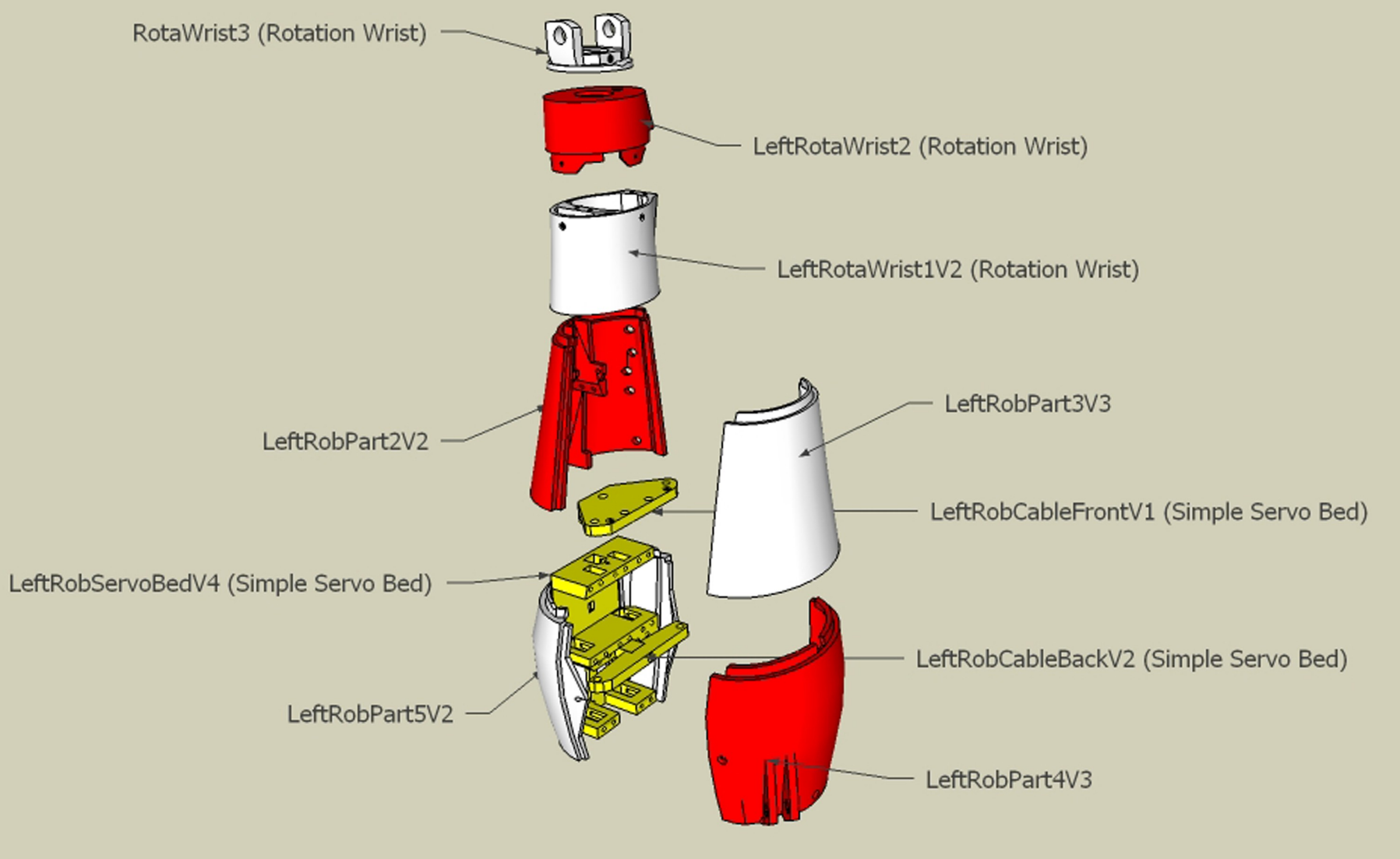

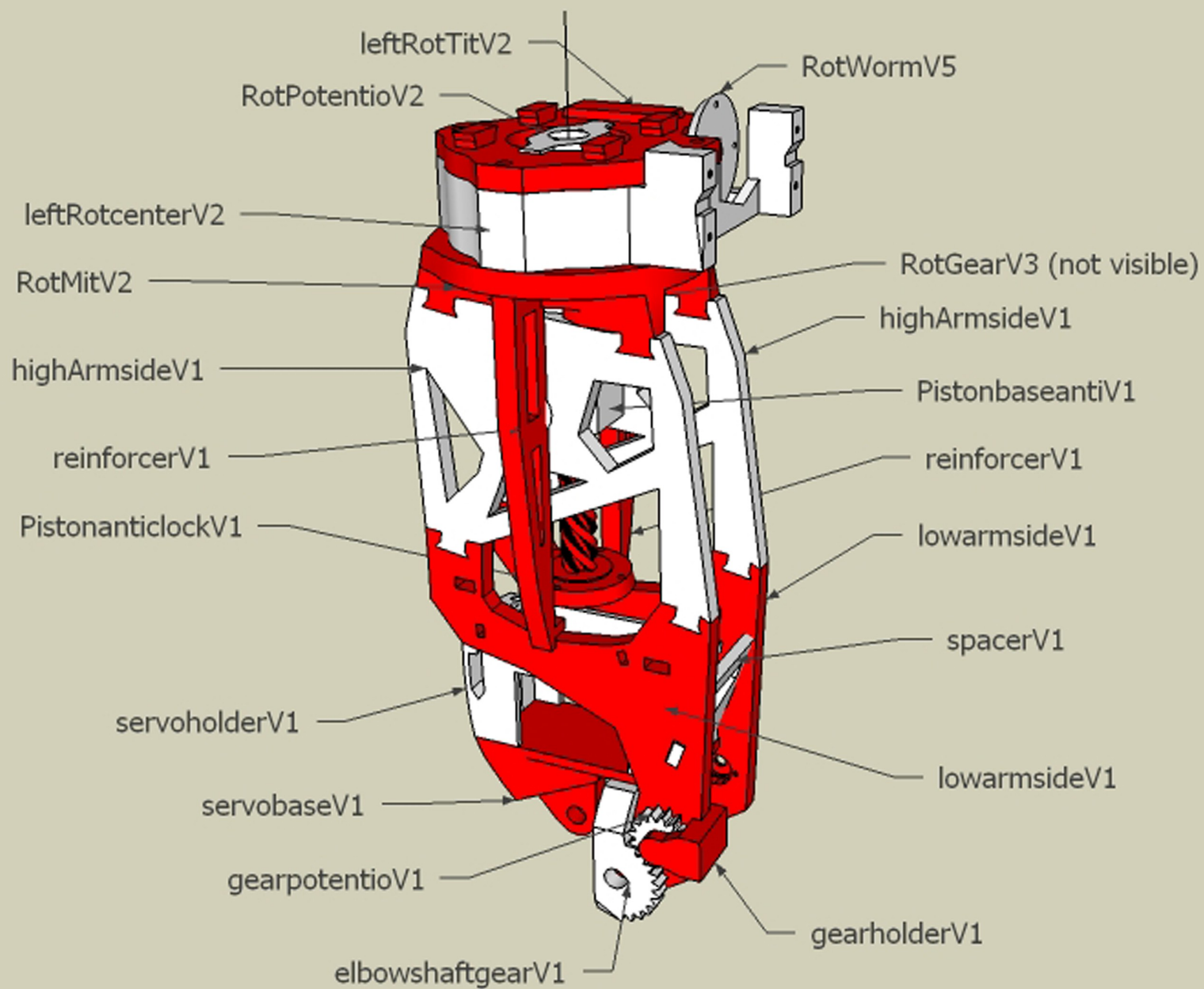

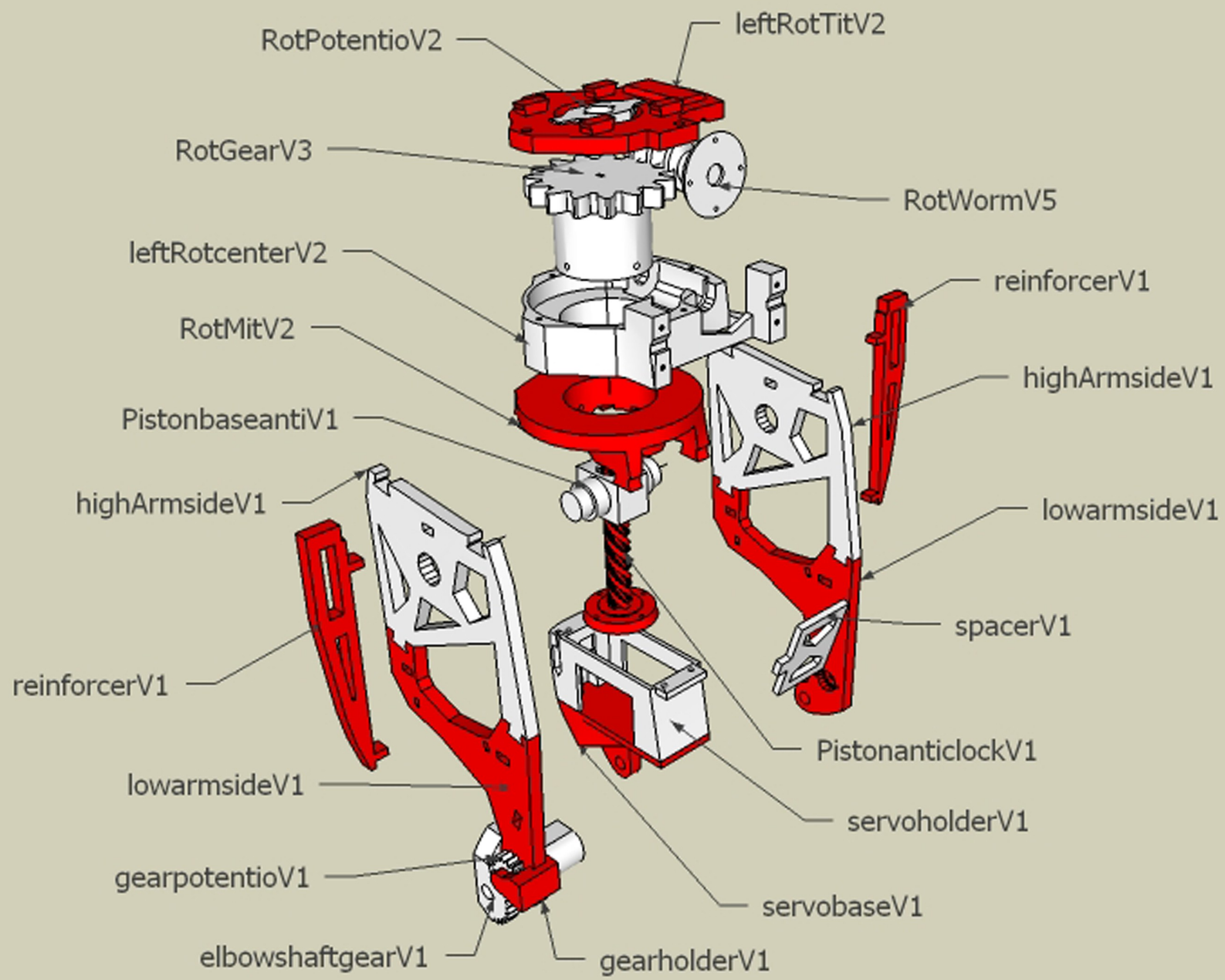

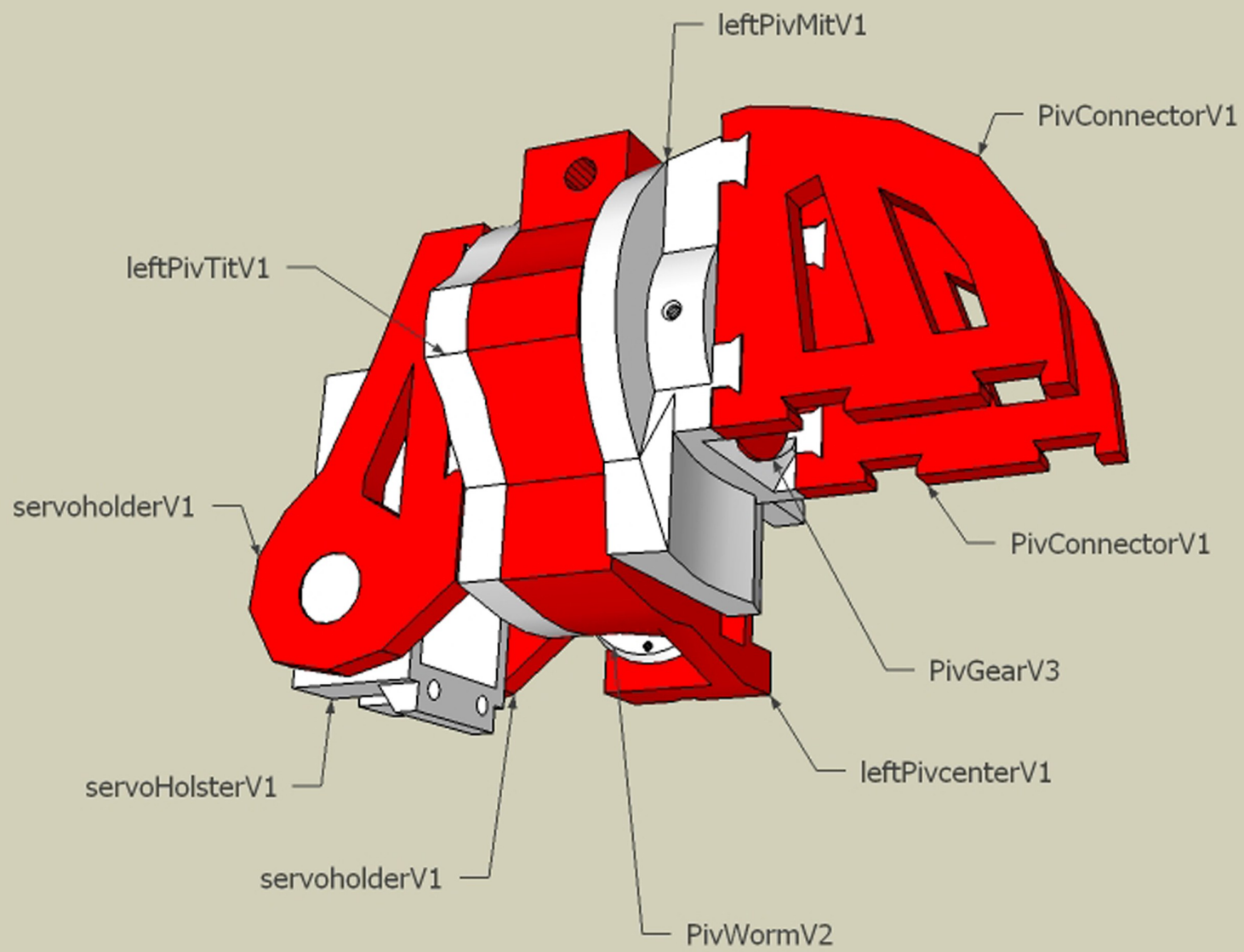

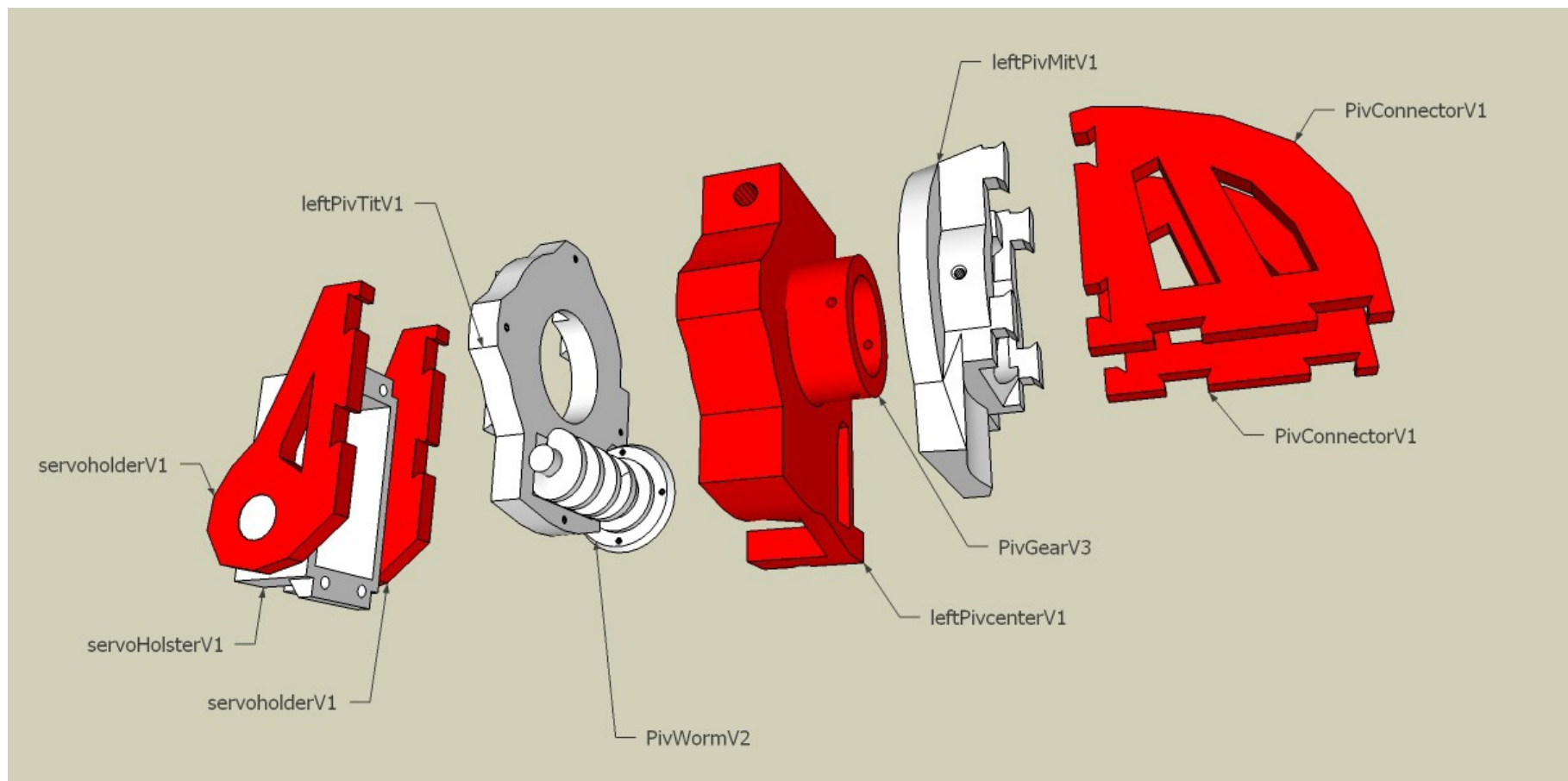

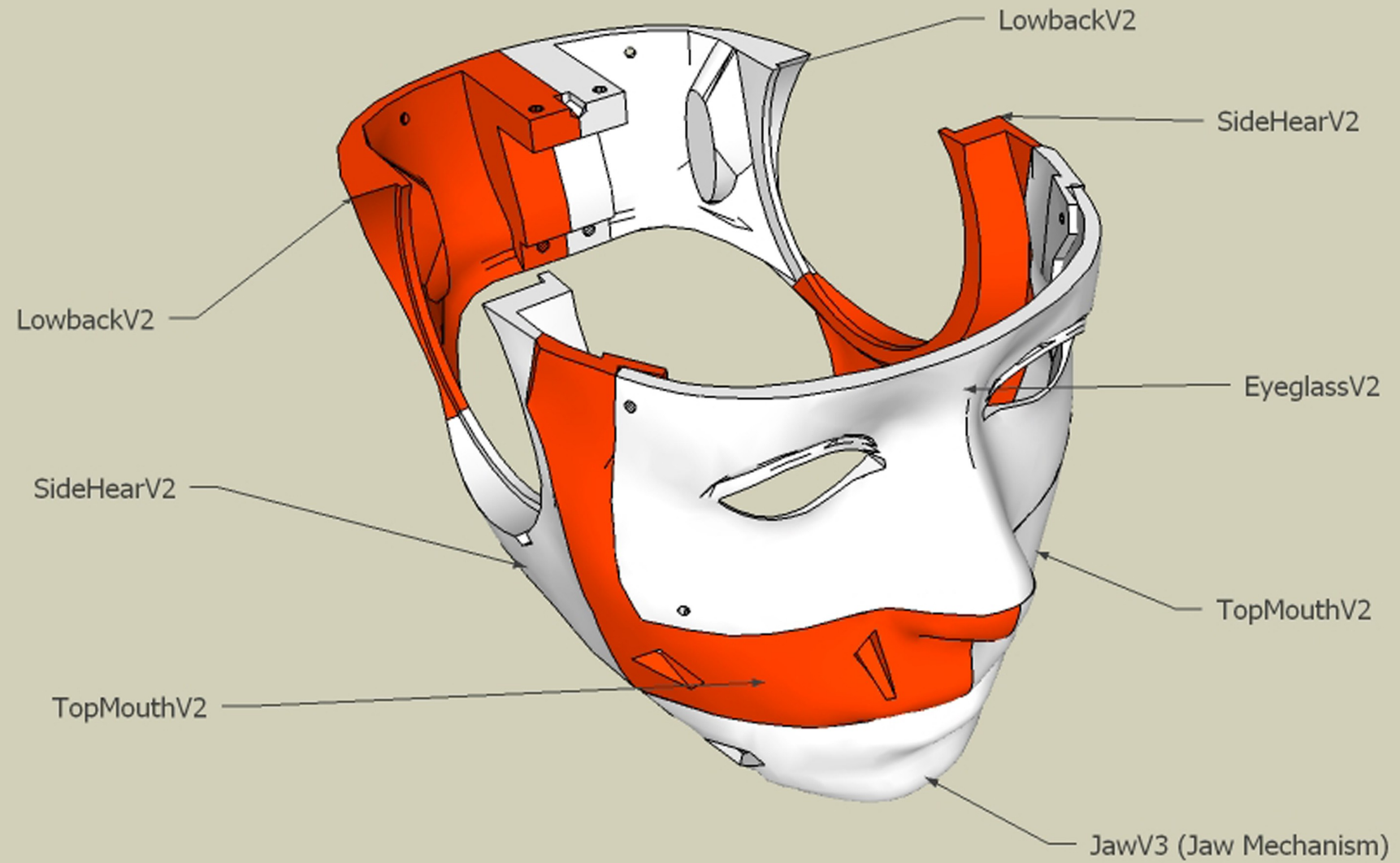

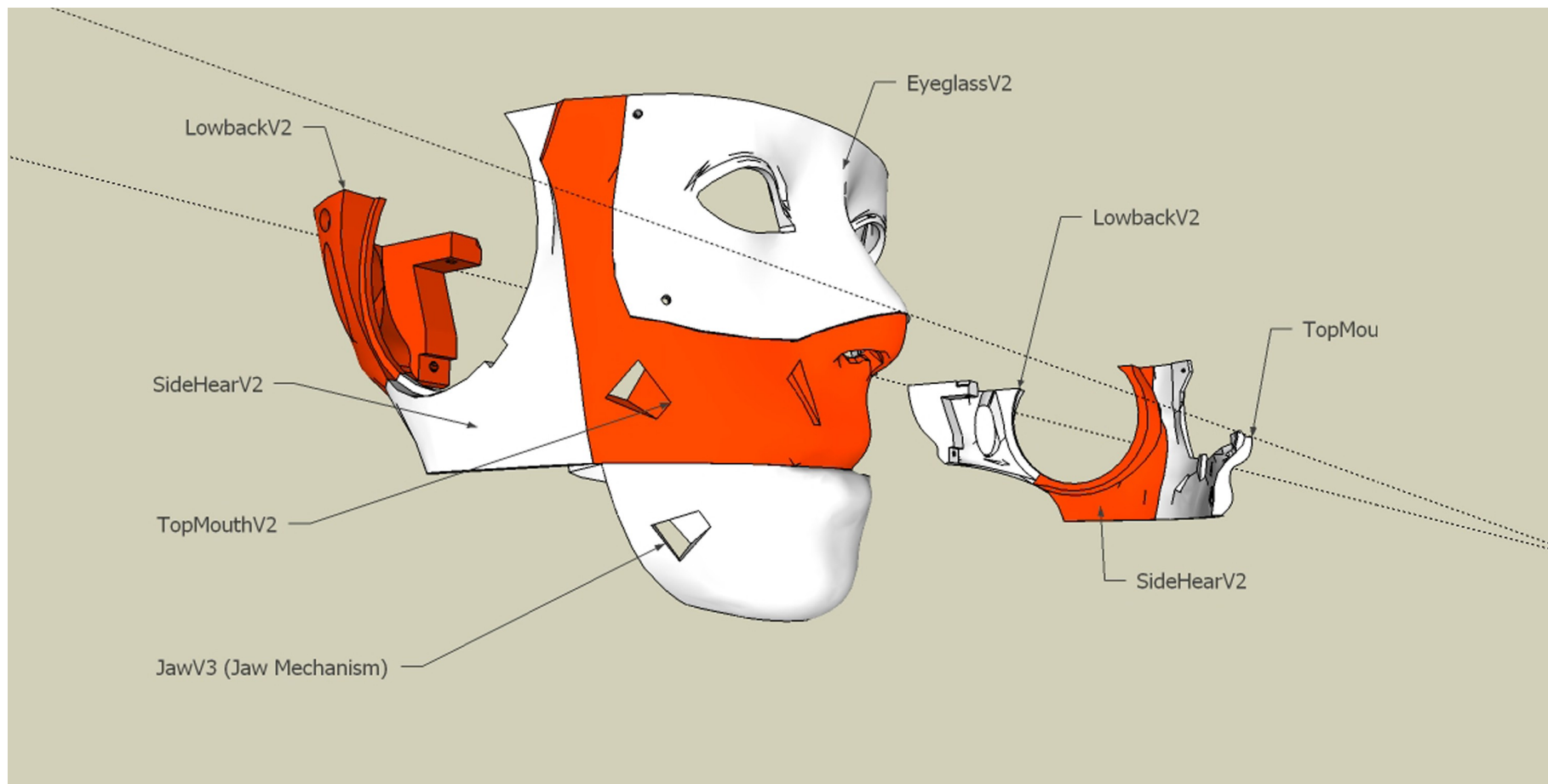

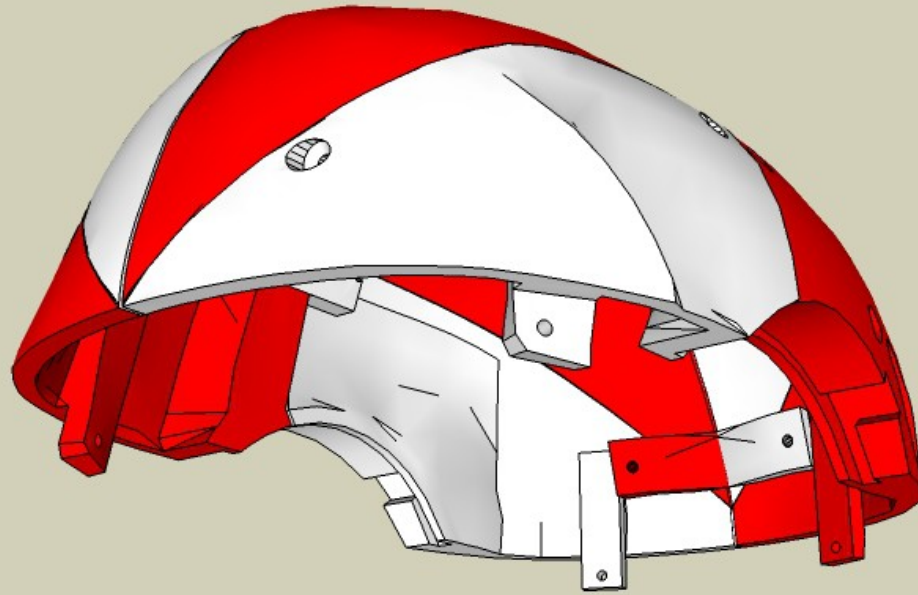

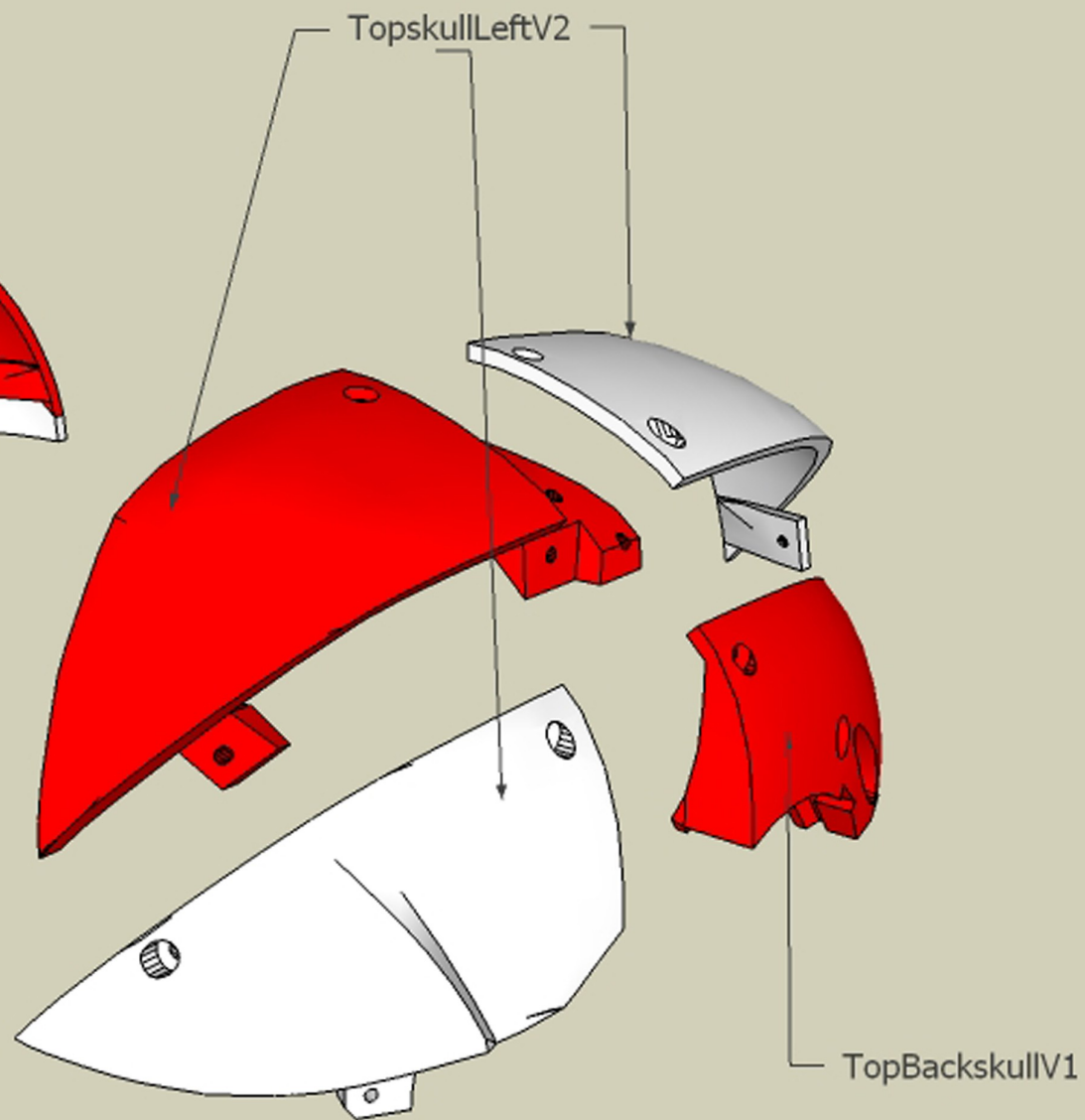
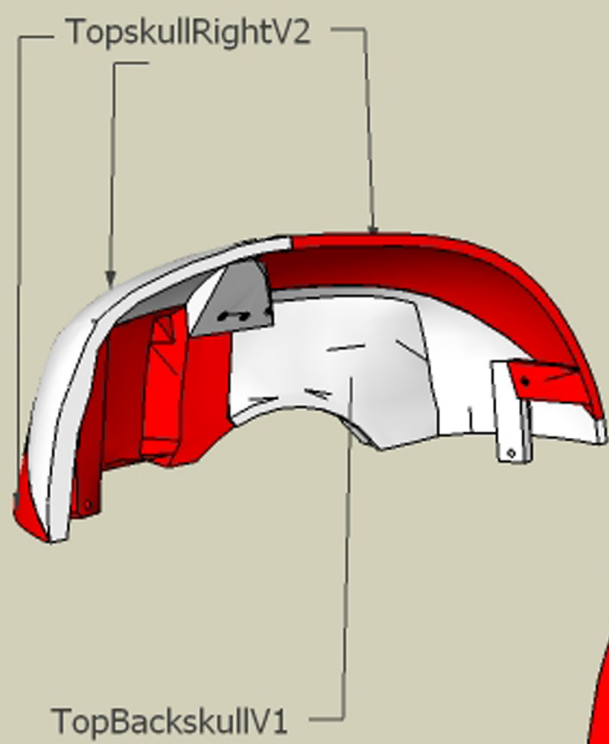

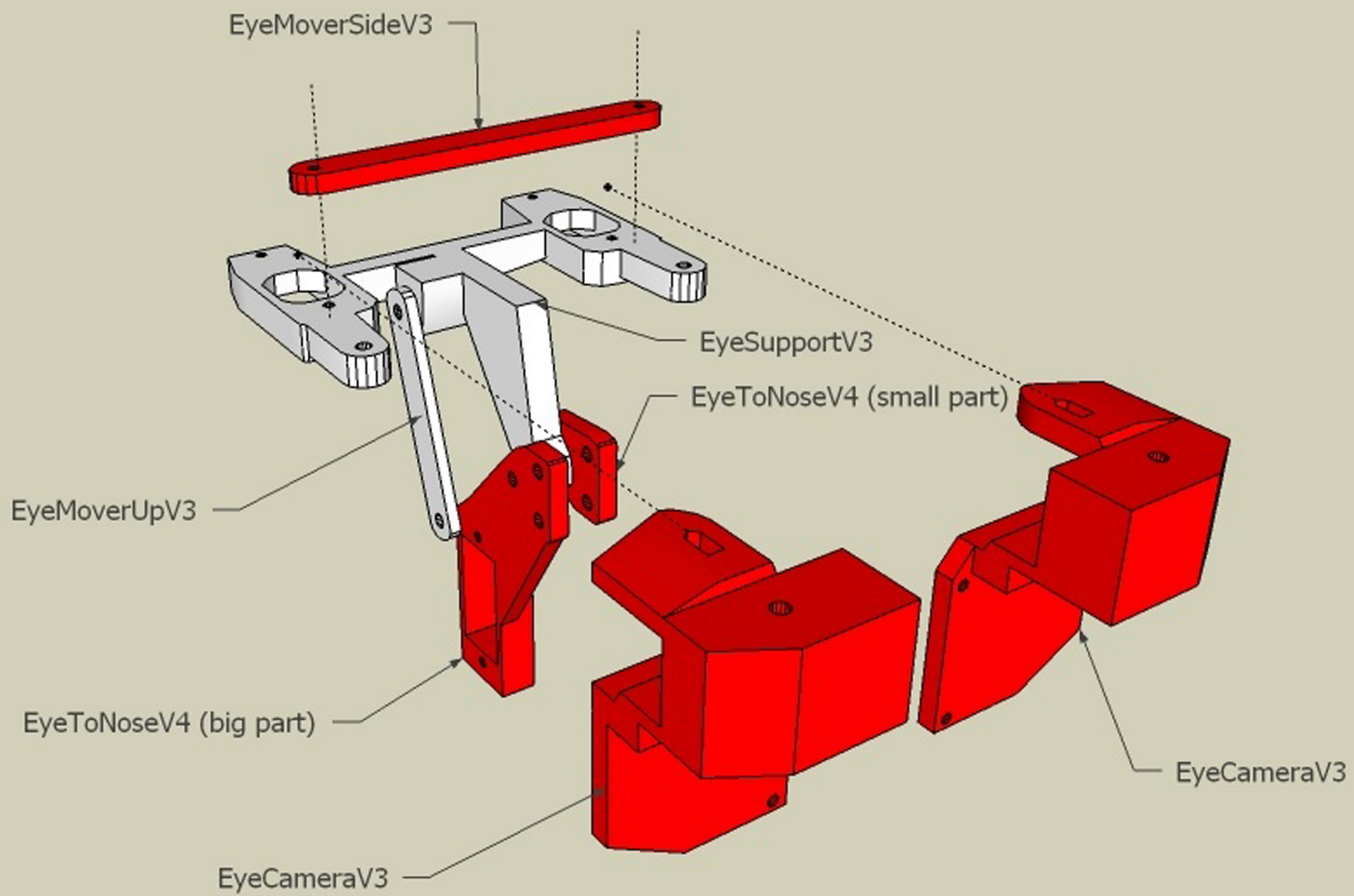

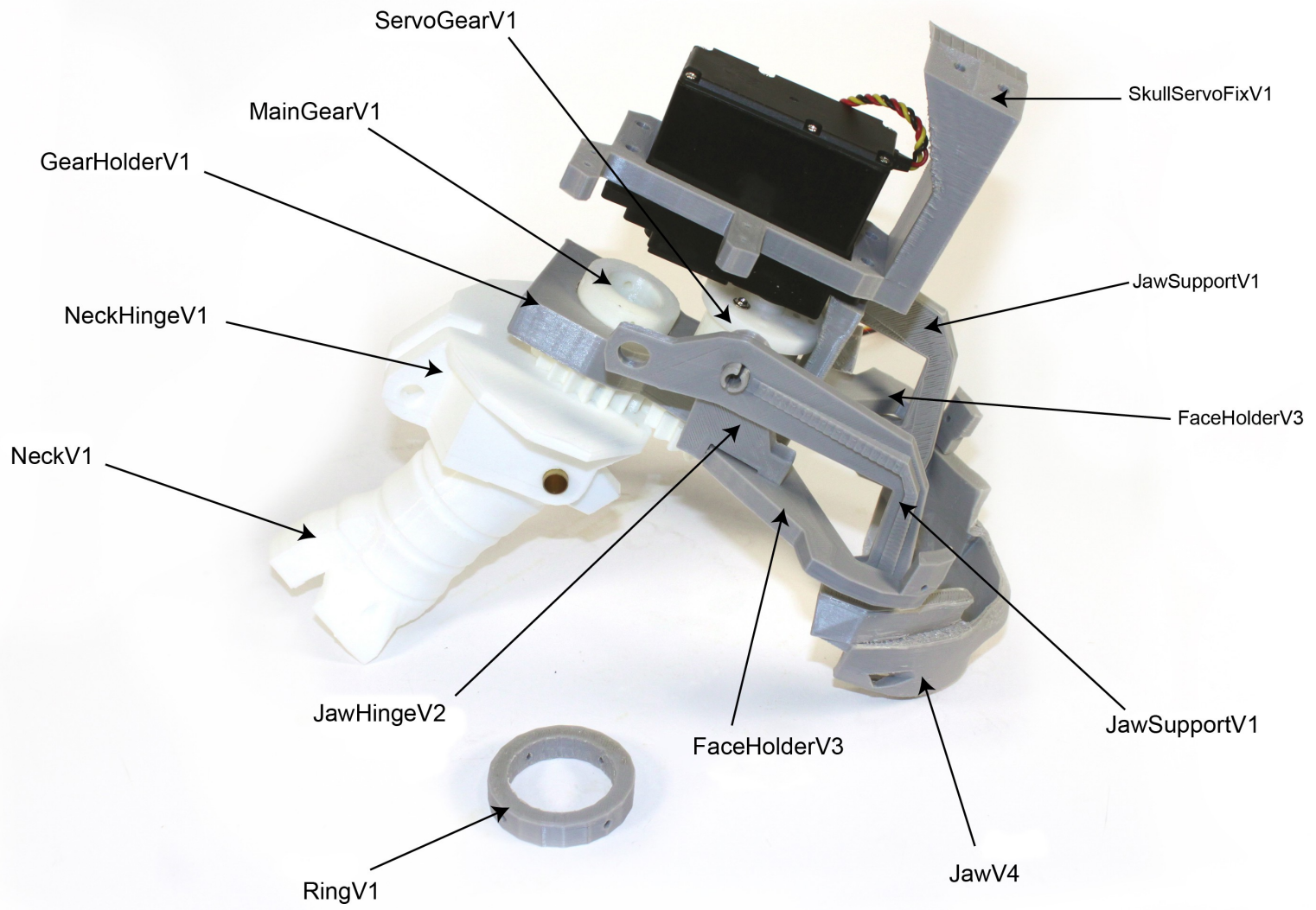

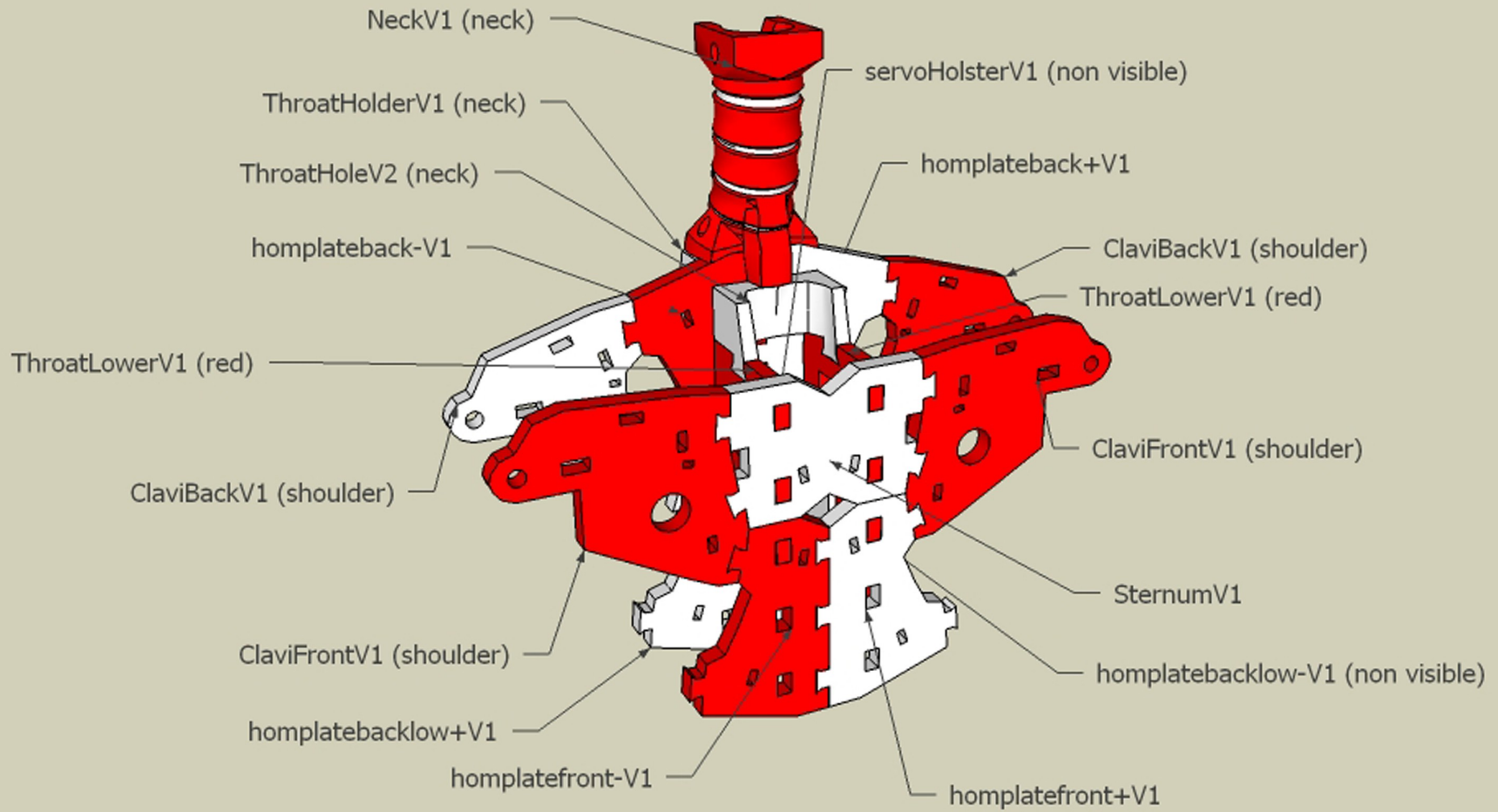

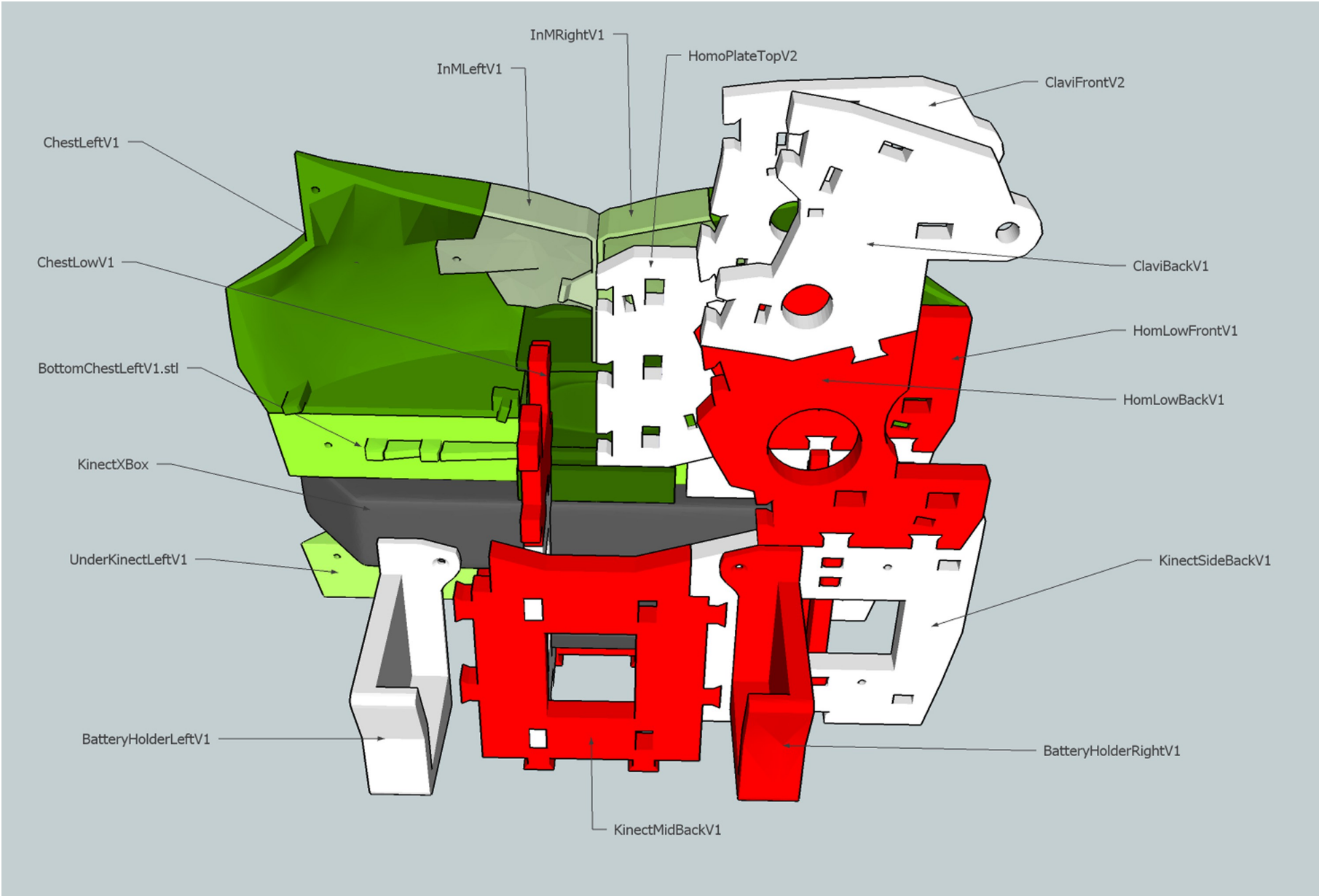

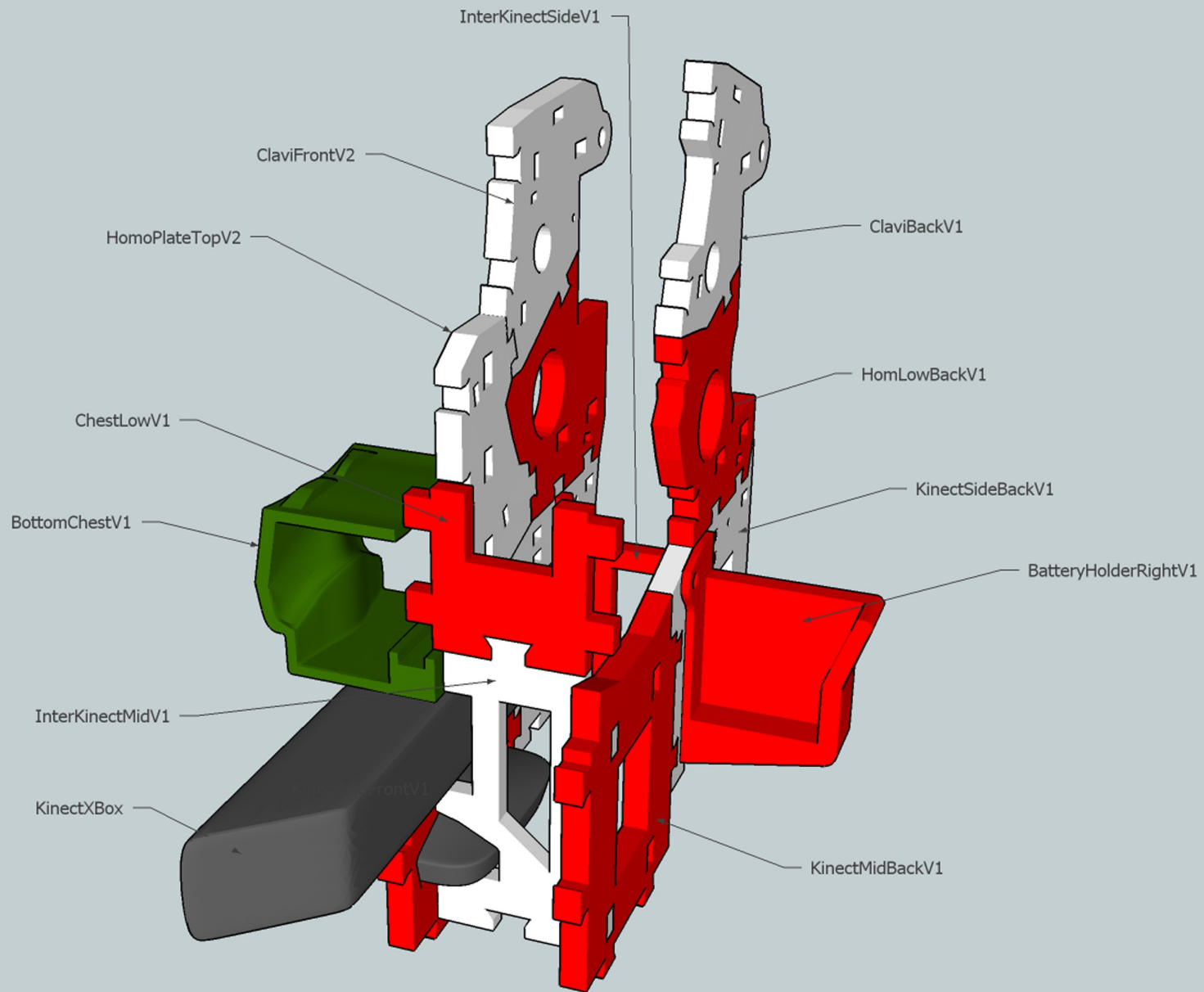

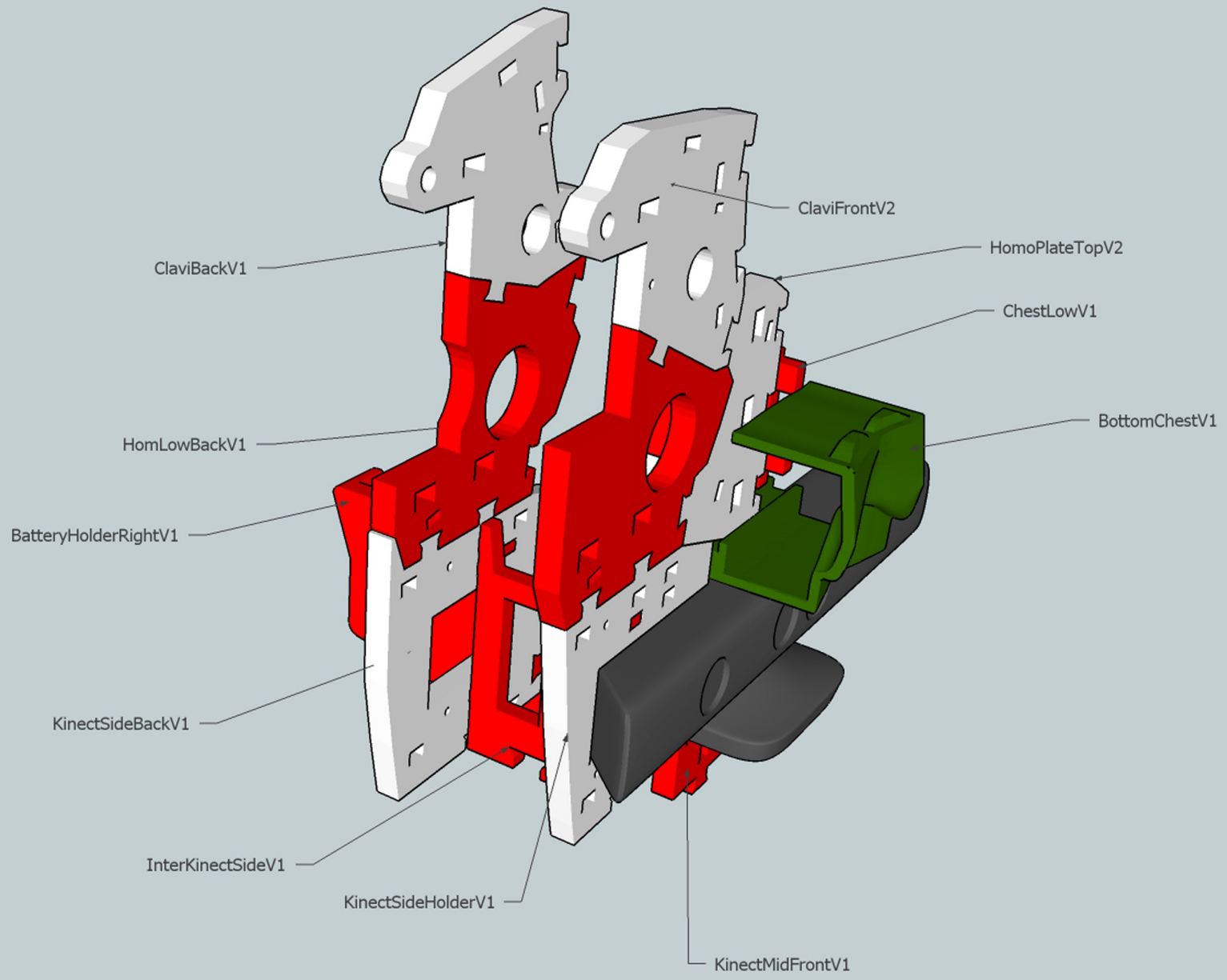

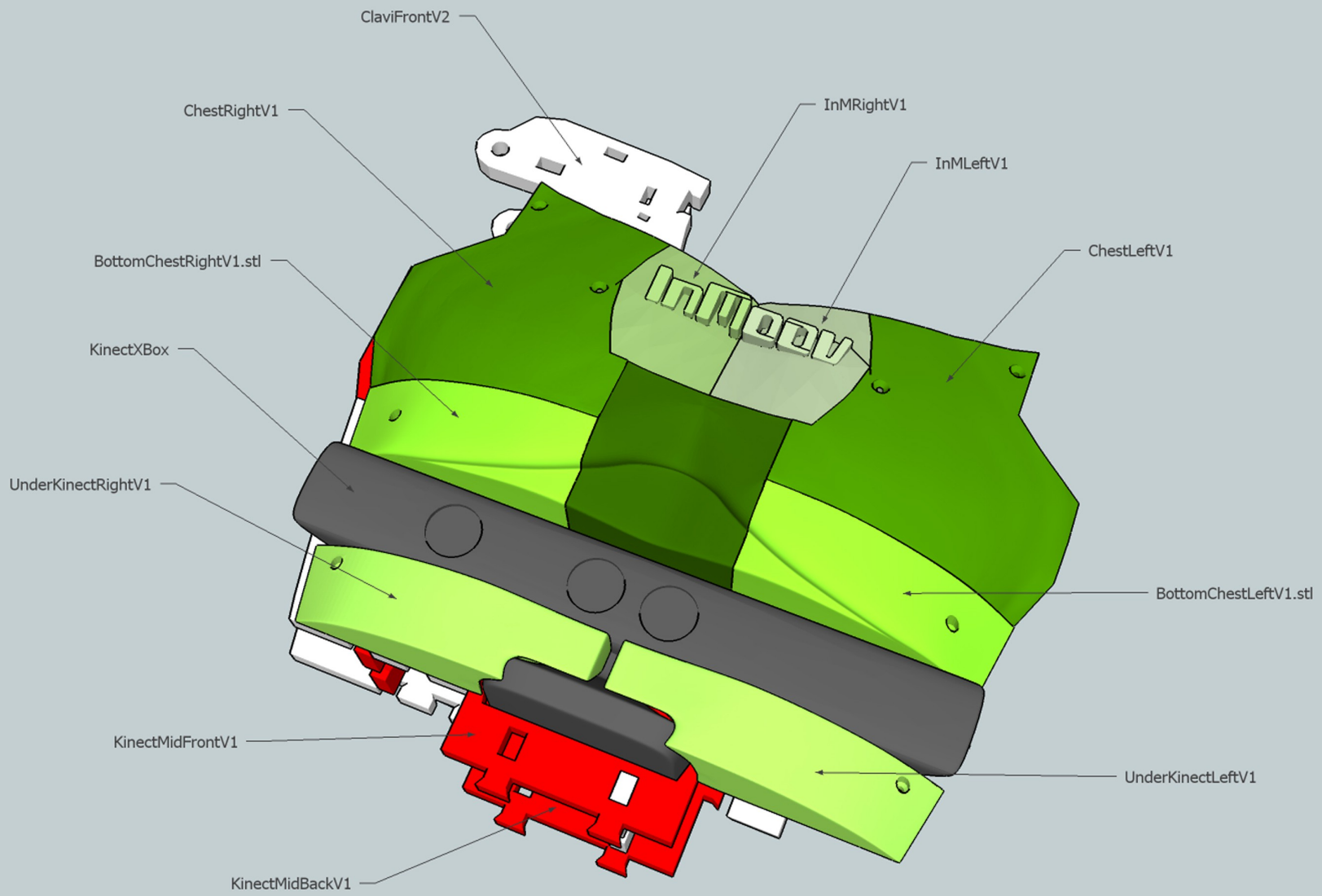

RollBackRightV1

RollBackLeftV1

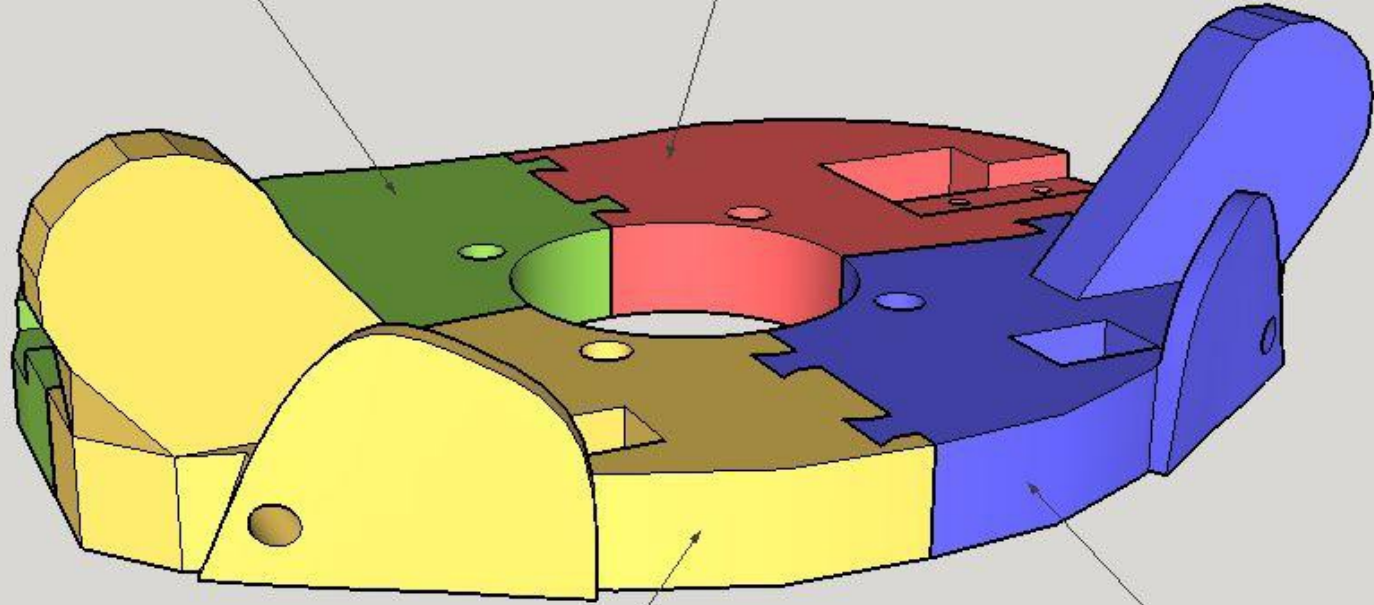

RollFrontRightV1

RollFrontLeftV1

ServoBackV1 - 2

ServoBackV1 - 1

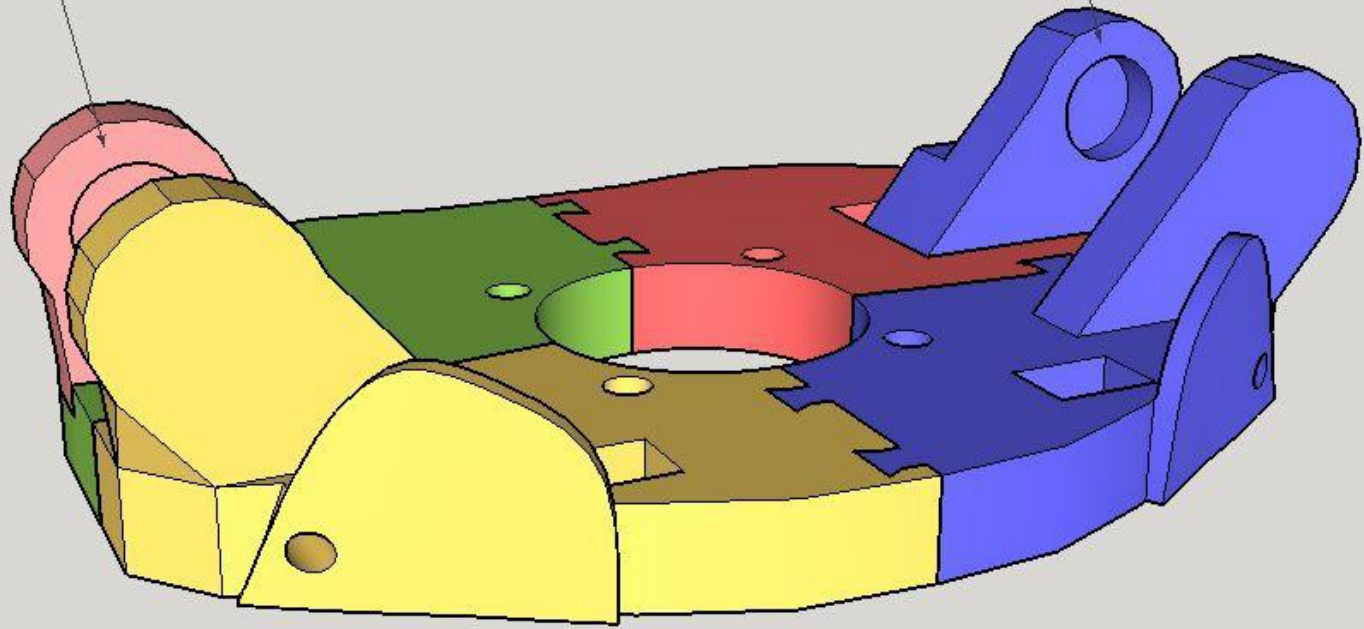

TStoBackStandRightV1

TStoBackStandLeftV1

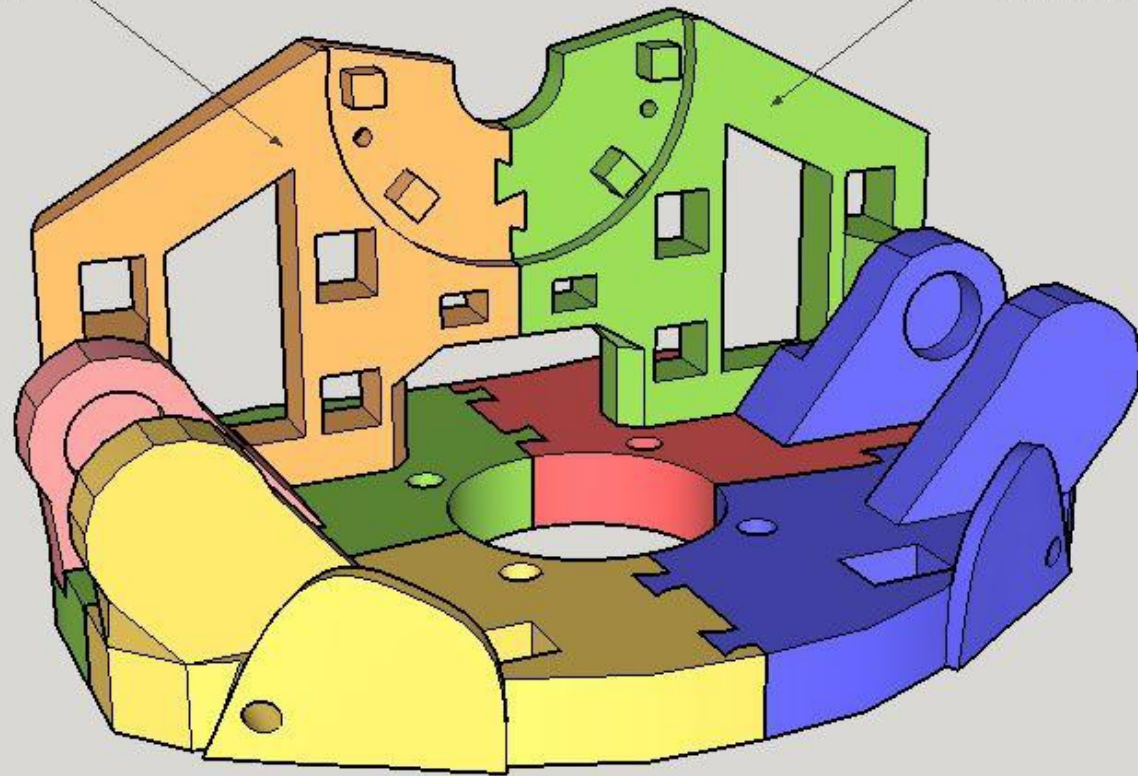

TStomRotBackV1

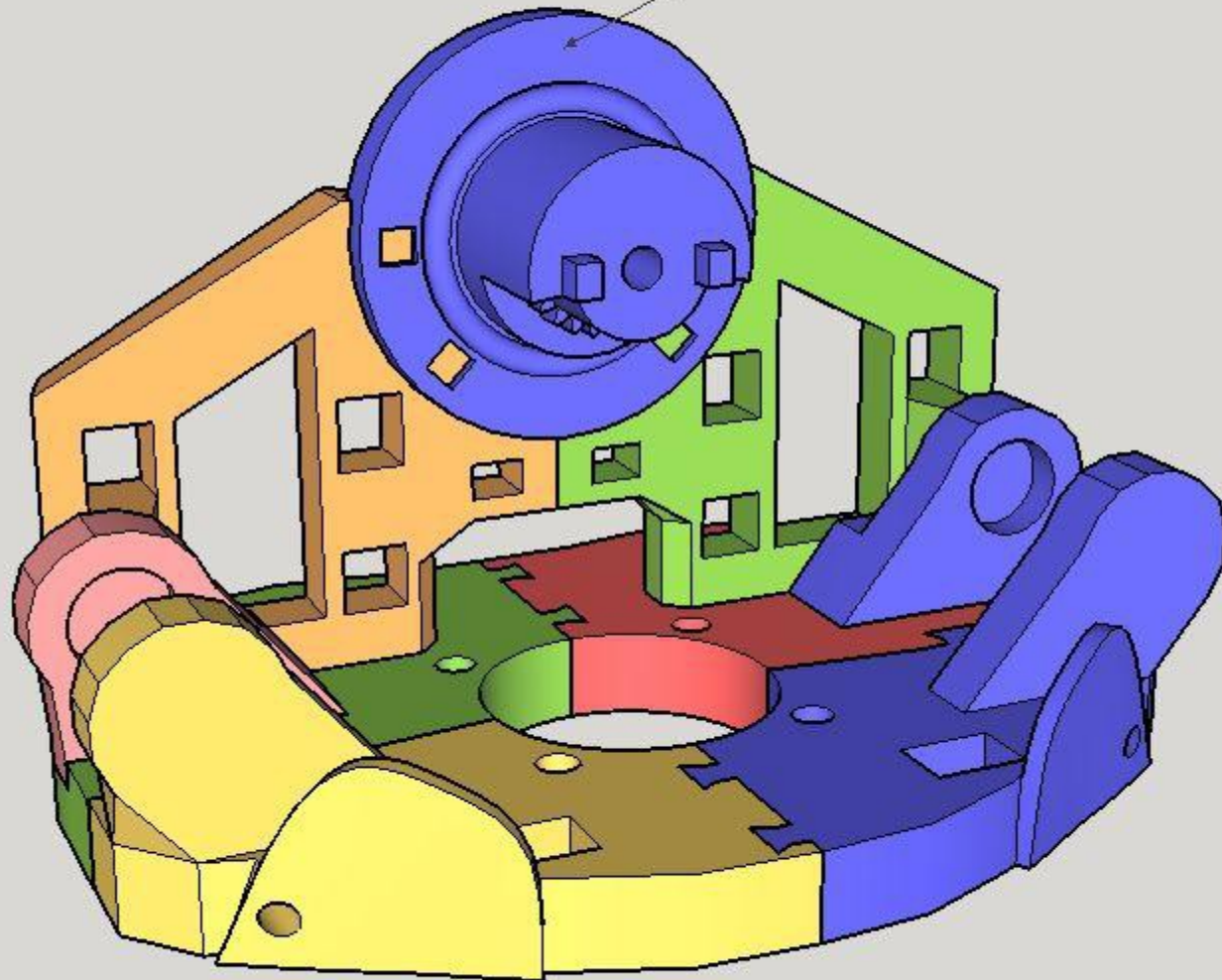

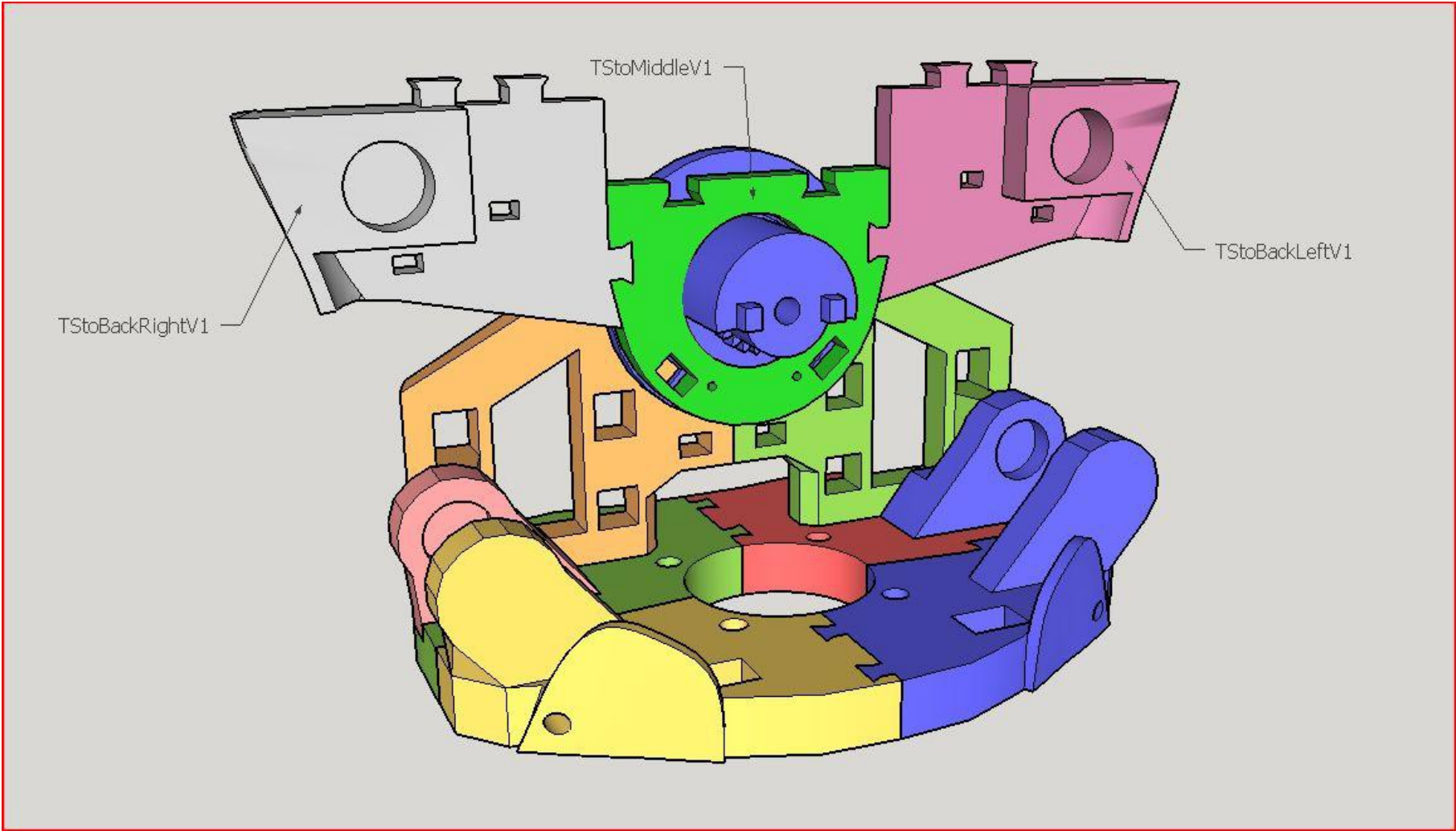

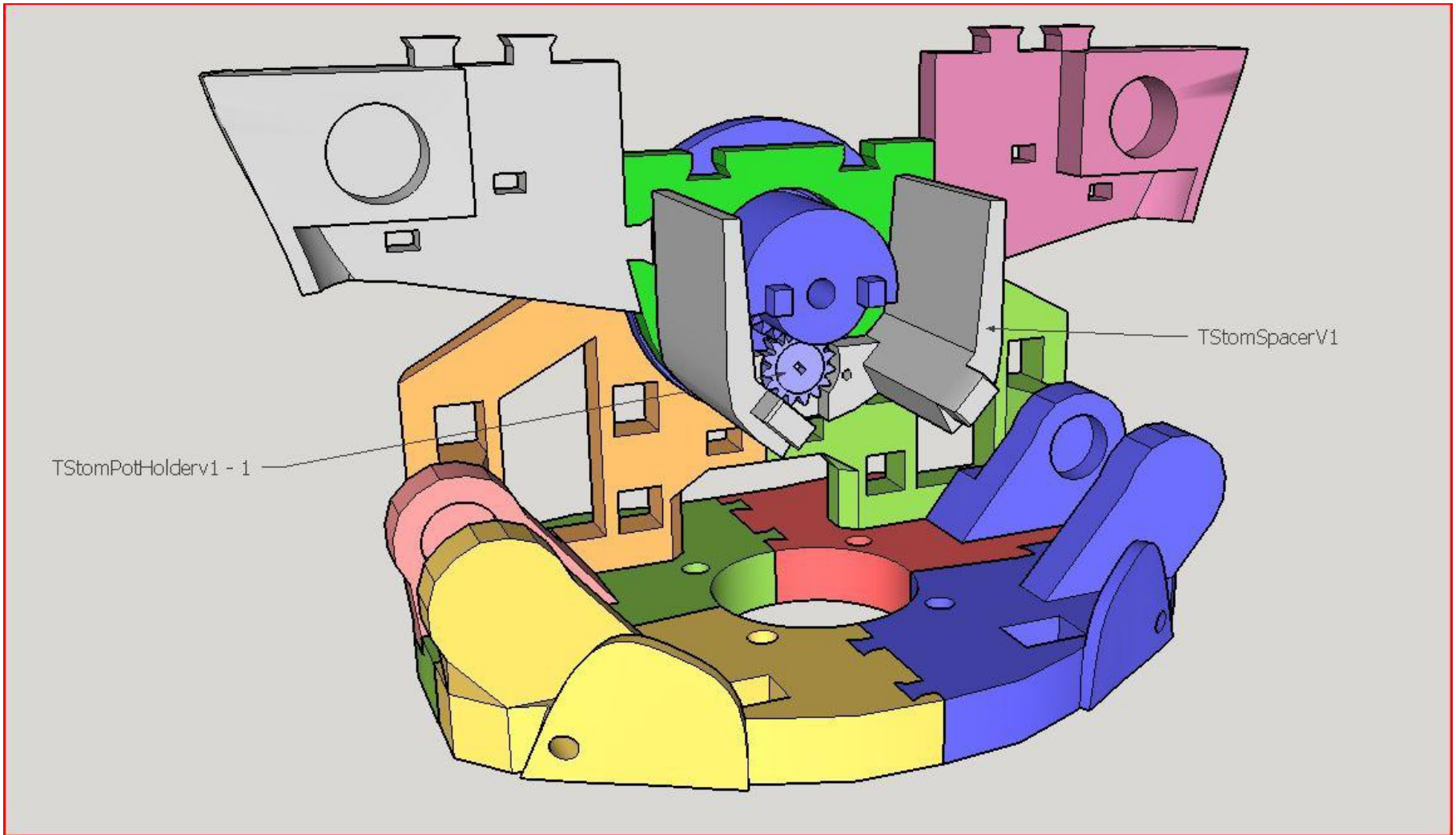

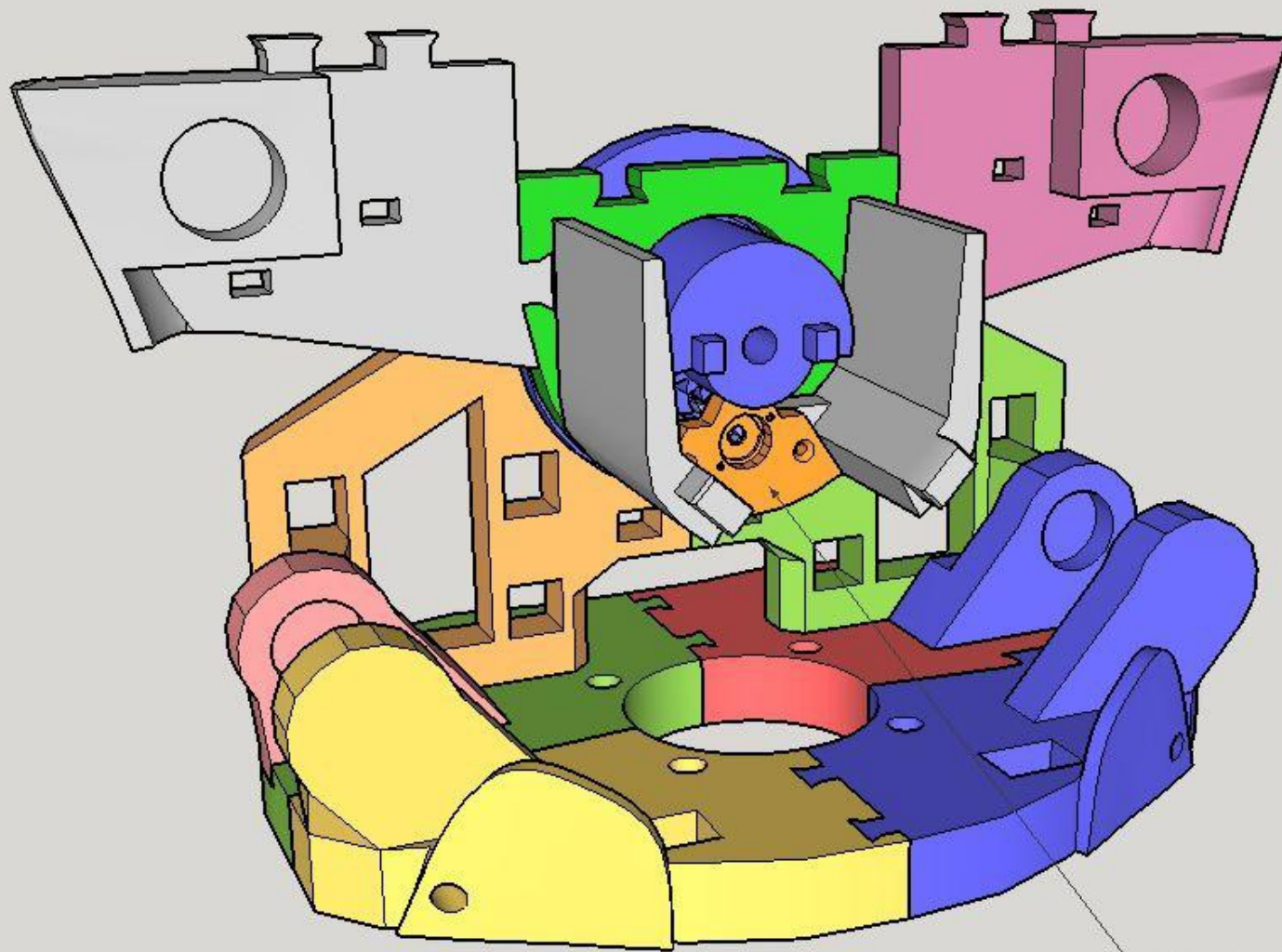

TStomPotHolderv1 - 2

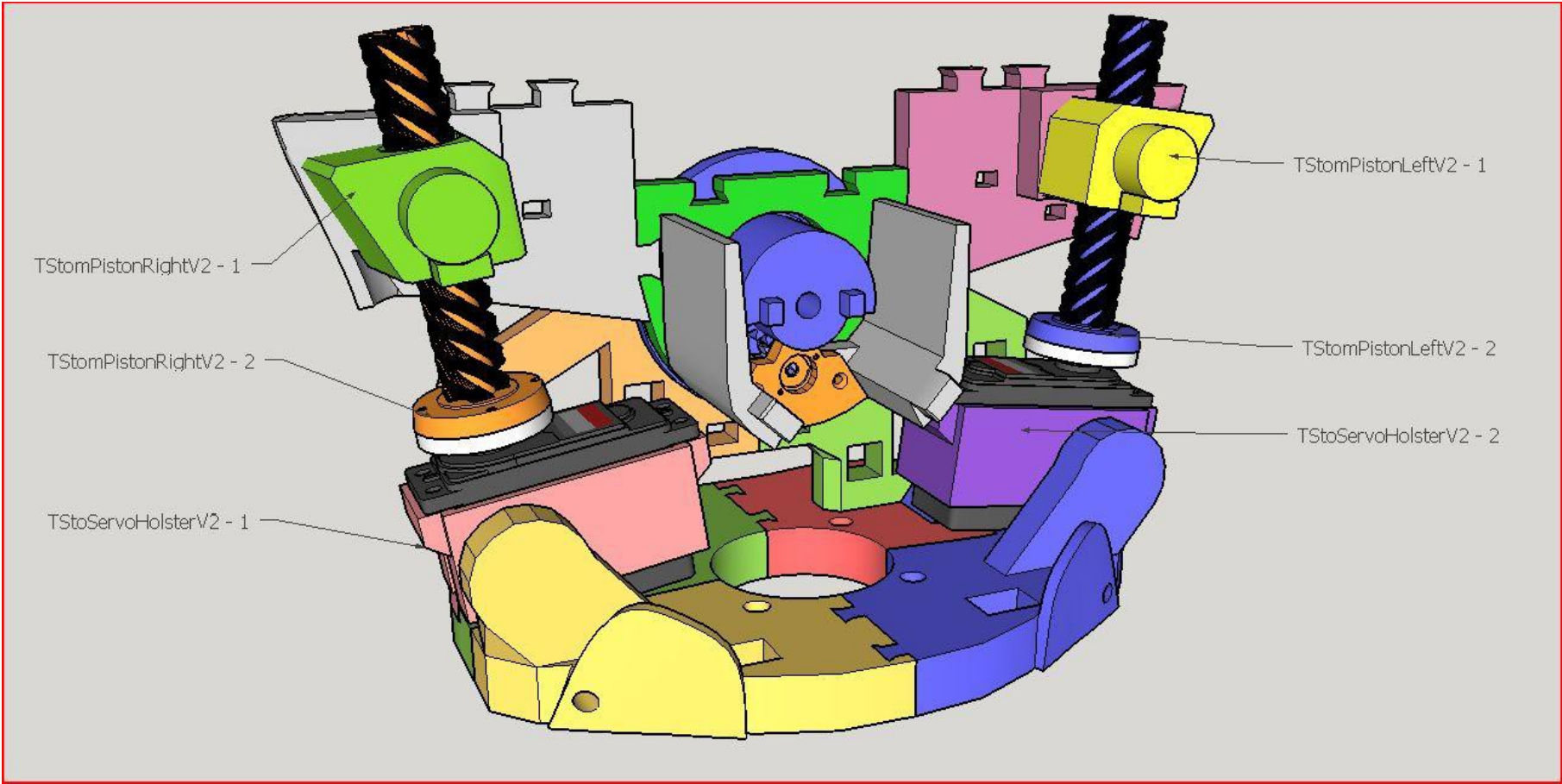

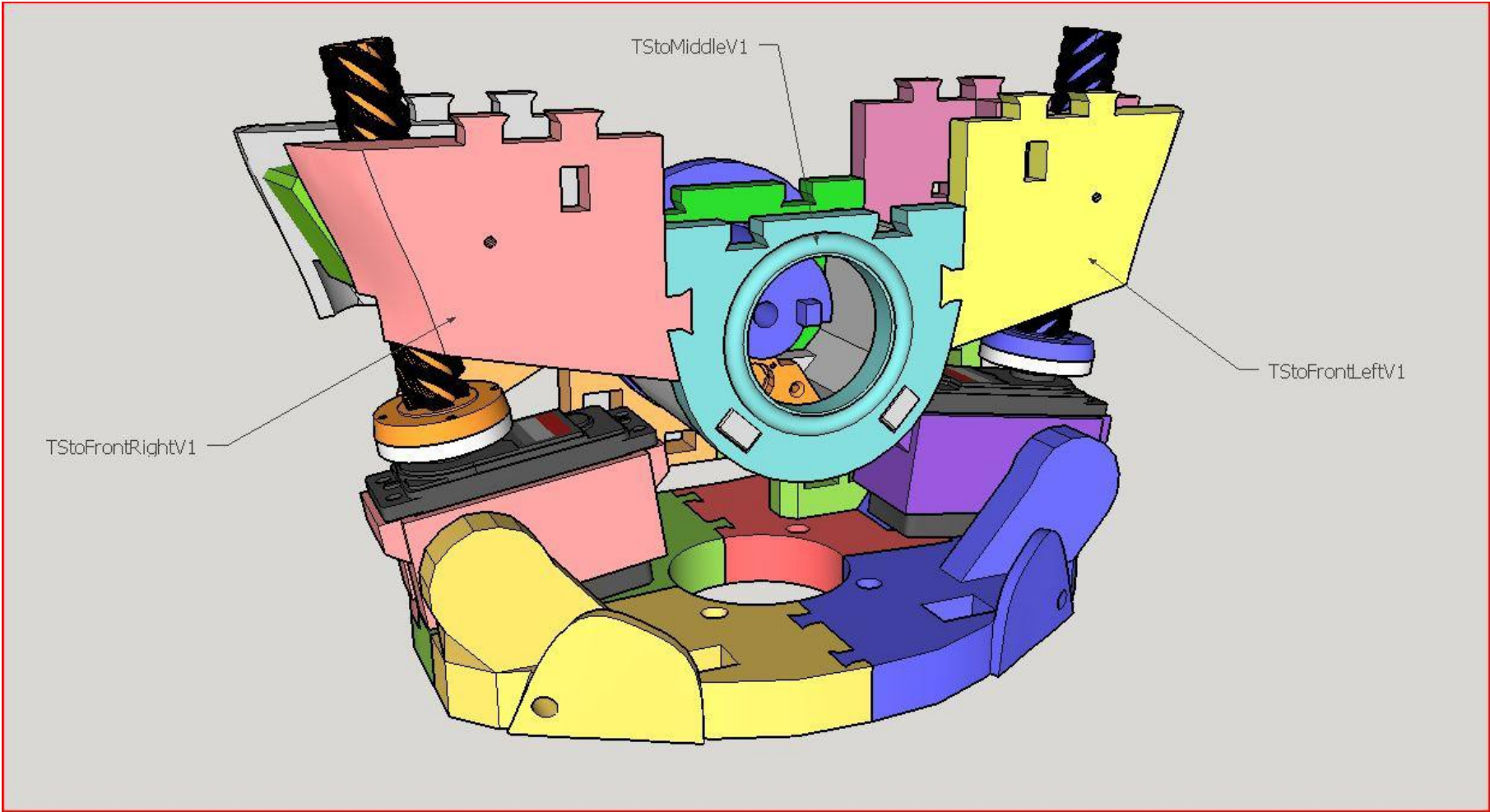

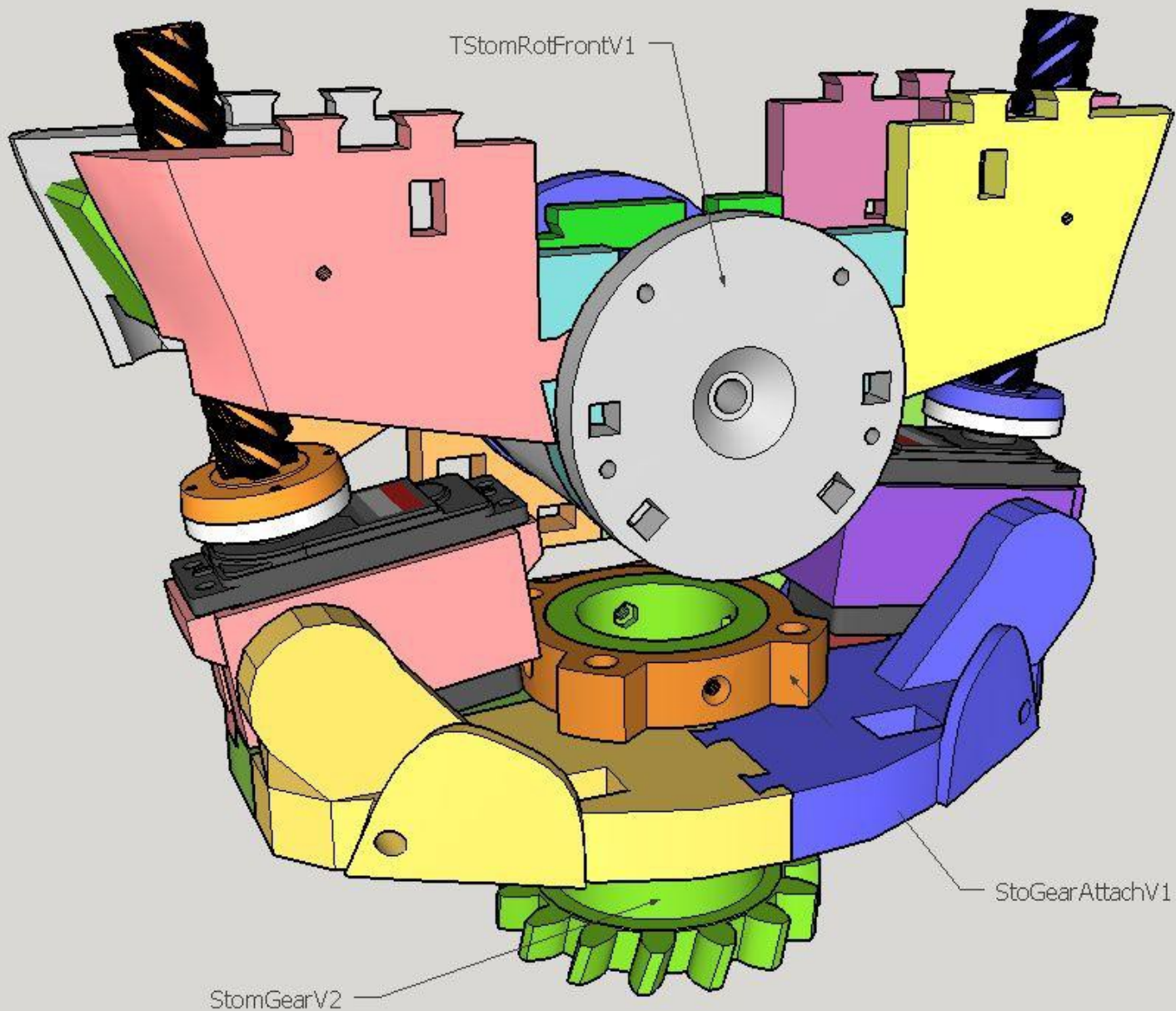

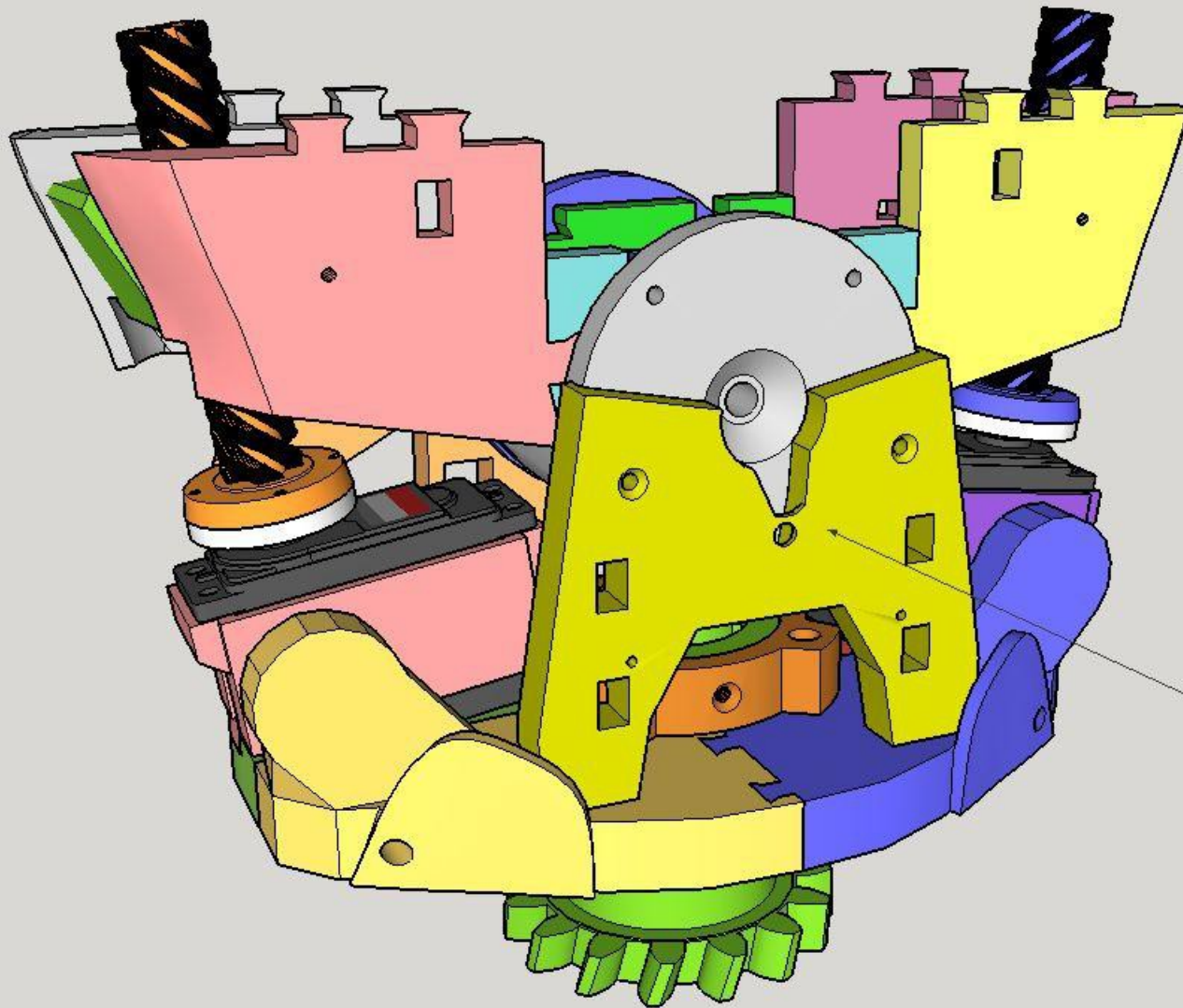

TStoFrontStandV2

